

CompactGrip

Questa gamma di morse permette di intervenire su 5 facce del particolare in lavorazione con riferimenti precisi in spazi contenuti

This series of vises allow machining operations on the 5 workpieces sides with perfect alignment in a space saving design

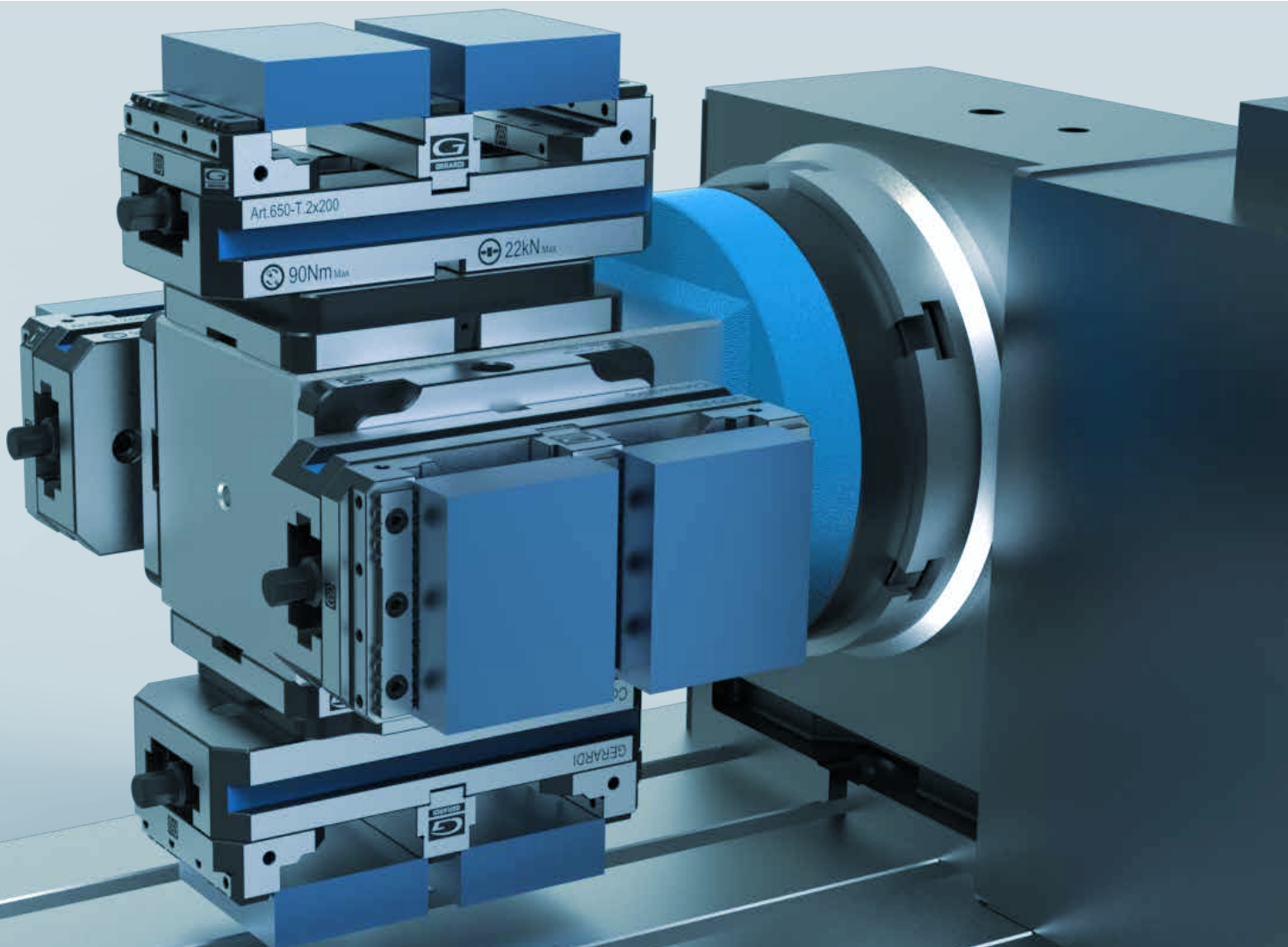

STD / Standard FLEX

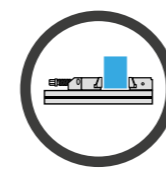

STANDARD & STANDARD FLEX

Morse modulari e cubi-morsa - Modular vises and vise-towers series
OK Morse ad altissima precisione - Highest precision vise series

1

XL / XL FLEX

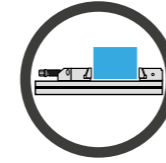

XL & XL FLEX

Morse modulari con basi extra lunghe
Modular vises with extra-long bases

2

MODULAR ELEMENTS

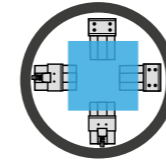

ELEMENTI MODULARI - MODULAR ELEMENTS

Elementi Modulari serie Standard & Standardflex per una versatilità estrema!
Standard & StandardFLEX modular elements series for an extreme versatility!

3

ACCESSORIES & SPARE PARTS



RICAMBI e ACCESSORI - SPARE PARTS & ACCESSORIES

Ricambi e accessori per morse Standard, StandardFLEX e XL
Spare parts and accessories for Standard, StandardFLEX and XL

4

FMS

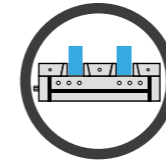

FMS

Un sistema modulare versatile per serraggi singoli, doppi ed autocentranti
A versatile modular system for single, double and self-centering clamping

5

MULTIFLEX

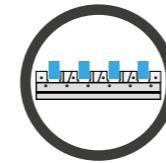

MULTIFLEX

Per serraggi multipli fino a 19 particolari di varie dimensioni
For flexible clamping of multiple workpieces of various sizes

6

MULTITASKING

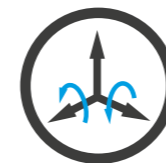

MULTITASKING

Morse autocentranti e sistemi di serraggio per applicazioni avanzate su centri a 5 assi
Vises for advanced applications on 5 axis machining centres

7

TOMBSTONES

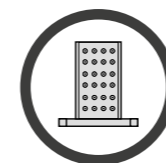

PORTAPEZZI MODULARI - MODULAR TOMBSTONES

Cubi, spalle, squadre, piastre, pallets, per centri di lavoro orizzontali
4 sides and 2 sides cubes, angles, plates, machine pallets, for horizontal machining centres

8

ZERO POINT

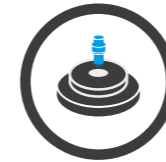

ZERO POINT

Il nuovo sistema di posizionamento e ancoraggio istantaneo
The new immediate positioning and clamping system

9

MAGNETIC PLATES



PIANI MAGNETICI - MAGNETIC PLATES

Un sistema elettropermanente ideale per operazioni di fresatura
An electro-permanent system ideal for milling operations

10

MODULAR CLAMPING TOOLS

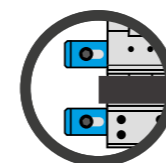

ELEMENTI MODULARI DI STAFFAGGIO MODULAR CLAMPING TOOLS

11



“ Morse ed attrezzature per il serraggio ed il posizionamento di particolari da lavorare

Vises and fixtures for workpieces positioning and clamping



What does workholding mean?

La vasta gamma di morse modulari e portapezzi che consente di rispondere ad ogni esigenza senza ricorrere allo speciale ed il rapporto qualità-prezzo dei prodotti unitamente ai 5 anni di garanzia, sono il vero punto di forza dell'azienda.

Gerardi è uno dei pochissimi costruttori in grado di realizzare qualsiasi tipo di attrezzature per presa pezzo e posizionamento chiavi in mano. I prodotti Gerardi sono sempre realizzati con i materiali più idonei e pregiati, le nostre morse sono in acciaio temprato e rettificato con durezza fino a 60Hrc e tutti i portapezzi per centri di lavoro orizzontali sono sempre in fusione monoblocco di ghisa stabilizzata a garanzia di maggior stabilità in fresatura e durata del prodotto.

Gerardi offers a widest range of precision modular vises, tombstones, zero point and magnetic plates suitable for any metalworking need unbeatable price-quality ratio of our range of products together with a 5-years warranty are our points of strenght.

Gerardi is one of the very few manufacturers able to design and manufacture any equipment for workholding and turnkey positioning and clamping. Gerardi's products are always made of the most suitable and valuable materials. Our vises are made of hardened ground steel with hardness up to 60Hrc and the range of tombstones for horizontal machining centres are always built in a one-solid cast iron block, which is a further guarantee of stability during milling operation and of unlimited lifetime.



**WE DESIGN
MANUFACTURE
& DISTRIBUTE
WORLDWIDE**

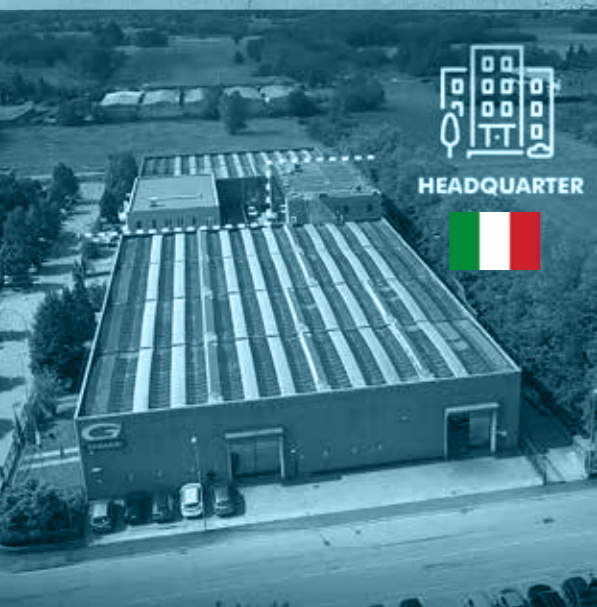

HEADQUARTER

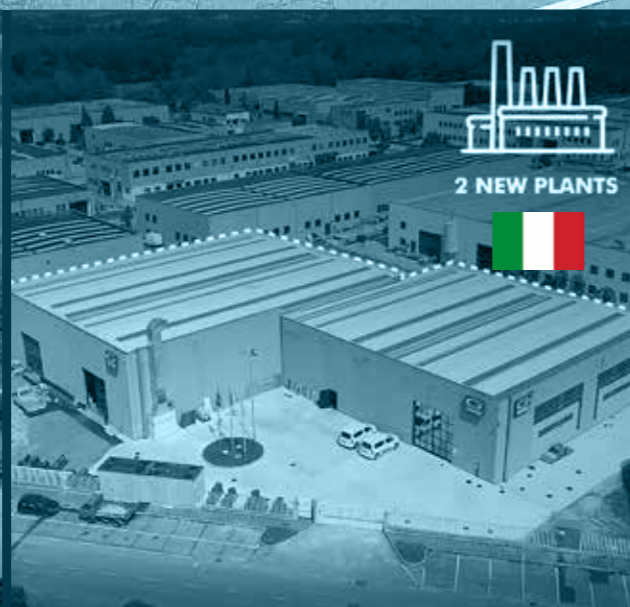

2 NEW PLANTS

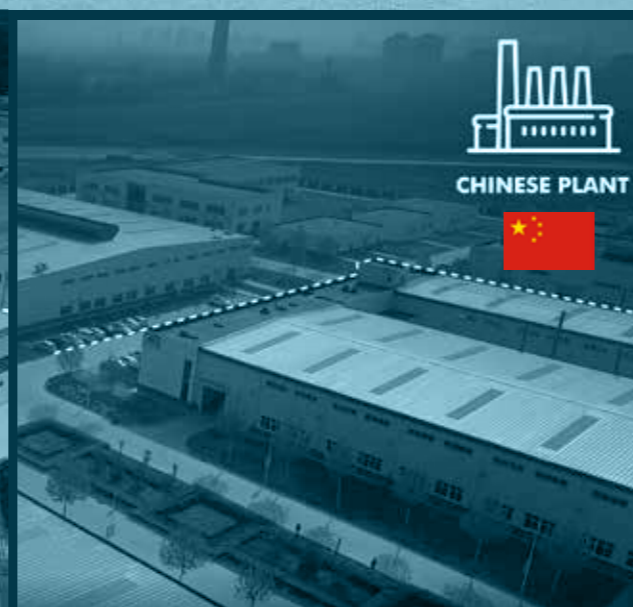

CHINESE PLANT



DESIGNING

Progettiamo e sviluppiamo soluzioni innovative per il serraggio e a lavorazione di particolari in acciaio, ghisa ed alluminio come ad esempio morse di precisione, teste angolari e portautensili motorizzati.

We design and develop innovative solutions for clamping, workholding and machining of workpieces in steel, cast iron and aluminum such as precision vises, angle heads and driven tools.



MANUFACTURING

I nostri centri di lavoro, gli utensili, i sistemi CAD/CAM e un team altamente qualificato contribuiscono alla realizzazione di componenti anche molto complessi e assicurano risultati di lavorazione eccellenti.

Machines, tools, CAD/CAM and a great Team contribute to the realization of even very complex components and ensure excellent machining results.



WORLDWIDE DISTRIBUTION

La distribuzione dei nostri prodotti è supportata da una rete di vendita molto estesa che comprende distributori e agenti provenienti da tutte le parti del mondo.

The distribution of our products are supported by an extensive network of wholesalers and agents that promote and are committed to sell all over the world.



CUSTOMER CARE

I nostri punti di forza sono la vasta disponibilità di ricambi pronti a magazzino, il nostro servizio di manutenzione e riparazione e l'assistenza tecnica telefonica gratuita pre- e post-vendita.

An extraordinary point of our strength is our huge spare parts stock, maintenance and repair service with free phone assistance of our technical Team before & after sales.



ITALIAN DESIGNING



WORLDWIDE DISTRIBUTION

71

1971

La Gerardi S.p.A. è stata fondata da Ivano Gerardi Sr. nel 1971 come terzista per la rettifica ed è situata vicino a Milano. Nel 1972, in seguito alla crisi petrolifera, è stata concepita e sviluppata la prima morsa modulare di precisione.

Gerardi S.p.A. Co. was established by Ivano Gerardi Sr. in 1971 as grinding subcontractor. The company is located near Milan, Italy. In 1972 due to the oil crises the first precision modular vise has been conceived and designed.

80

1980

Negli anni '80 l'azienda è cresciuta diventando la maggior produttrice di morse modulari di precisione della nazione e una delle aziende leader del mercato della Comunità Europea e la qualità dei suoi prodotti è stata riconosciuta in tutto il mondo. Nel frattempo l'azienda ha continuato a sviluppare la sua tecnologia di rettifica con un concetto totalmente nuovo alla base del progetto. Gerardi S.p.A. ha inoltre lanciato una vasta gamma di Teste Angolari per centri di lavoro e utensili tradizionali e Portautensili Motorizzati per torni CNC. Attraverso una campagna di marketing globale, l'azienda ha portato il volume della produzione da pochi pezzi a migliaia di prodotti venduti e la sua tecnologia è conosciuta e venduta in tutto il mondo.

In the Eighties the company grew to become the largest Italian vise manufacturer and one of the leaders in the European Common Market and the quality of its products got worldwide renown. Meanwhile the company developed its own Grinding machines technology with a totally new concept at the base of the project. Moreover Gerardi S.p.A. launched a wide range of Angle Heads for traditional machine tools and machining centers and Driven Tools for C.N.C. lathes. With worldwide marketing efforts, the company has brought the production from few pieces to thousands with products and technologies known and sold all over the world.

90

1990

Nello stesso periodo l'azienda ha fondato una joint-venture in Cina per la produzione di particolari e di alcuni tipi di morse in collaborazione con l'industria aerospaziale cinese AVIC. Grazie ai consistenti investimenti la nuova azienda è oggi controllata da Gerardi e sta raggiungendo la stessa posizione di eccellenza ottenuta nel mercato europeo, sia nel mercato asiatico che in Nord e Sud America.

In the same period the company established a joint-venture in China for the manufacturing of parts and types of vises together with the Chinese aerospace industry AVIC. Thanks to major investments the new company is today controlled by Gerardi and is achieving the same excellent leadership results in Asia and North & South America as those accomplished in Europe.

00

2000

Con importanti investimenti e un impegno finanziario consistente, è stata costituita una filiale negli Stati Uniti, vicino a Chicago, e nel 2007 è stata aperta una nuova succursale a Stoccarda, in Germania, con lo scopo di servire al meglio i mercati locali.

After the set up of a US subsidiary Co. near Chicago, a new German branch has been established in Stuttgart / Germany in 2007 in order to better penetrate and service the local markets. Of course this meant a huge financial effort and investments.

12

2012

Gerardi S.p.A. ha aperto un nuovo stabilimento produttivo per implementare la produzione di Teste angolari, Portautensili motorizzati e Portapezzi e piastre personalizzati. E' stata inoltre aperta una nuova succursale in India per la produzione di attrezzature per il mercato indiano.

Gerardi set up a new manufacturing plant to increase the Angle Heads, Driven Tools, tailor made Tombstones and plates production and a new company in INDIA for the manufacturing of fixtures for the Indian market.

20

2020

Installazione di un nuovo impianto logistico per incrementare l'efficienza della distribuzione e delle spedizioni.

Set Up of a new logistic plant to improve efficiency in shipments and distribution.

24

2024

Lo staff della Gerardi conta oggi oltre 200 persone con un'età media inferiore ai 40 anni. Le posizioni manageriali e di rilievo sono occupate da personale che è maturato all'interno dell'azienda grazie a formazione interna ed esperienza. La percentuale di esportazioni è oggi più del 70% della nostra produzione totale ed interessa più di 60 paesi in tutto il mondo. Investiamo inoltre il 10% del fatturato in ricerca tecnologica per la progettazione e realizzazione di nuovi prodotti. Gli investimenti complessivi dell'azienda superano i 20 milioni di Euro.

The Gerardi S.p.A. Co. staff now numbers over 200 employees with an average age of under 40. In the company all the top roles and manager positions were acquired through internal training and experience. Our total export is today more 70% of our total production in more than 60 countries around the world and we invest about 10% of our total turnover in advanced technological research for designing & manufacturing new products. The overall investments of the company exceed € 20 Million.

WHAT'S NEXT

Il mercato è oggi molto esigente: la competitività è data dalla continua capacità di offrire velocemente nuovi prodotti che richiedono costantemente nuovi aggiornamenti e miglioramenti. La produzione è impegnata a seguire questa continua evoluzione offrendo prodotti di alta qualità in breve tempo e ad un prezzo competitivo.

The market is nowadays highly demanding: competitiveness is played on the continuous ability to offer new products that quickly and constantly require new updated and upgraded versions. Production is forced to follow these continuous developments by supplying high quality products in a short time and with competitive prices.

OUR GOAL

Il nostro obiettivo è di fornire soluzioni che permettano di aumentare la produttività e l'efficienza garantendo un rapporto qualità prezzo imbattibile.

Our Goal is to supply solutions able to increase workshops productivity and efficiency with an unbeatable price / quality ratio

Photo: Ivano Gerardi Jr. (CEO) and Ivano Gerardi Sr. (Founder of Gerardi S.p.A)

Cubo portapezzi a reticolo monoblocco

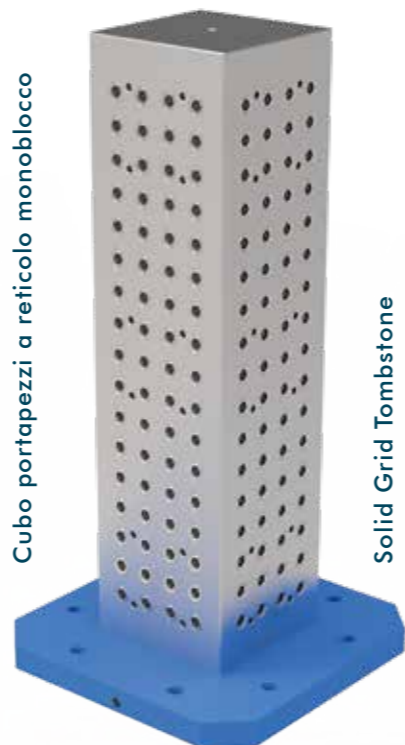

Solid Grid Tombstone





Main Clients



WHERE WE ARE

Headquarter

Branches

Distributors

More than 200

200 worldwide



Headquarter & 3 plants in Italy
80 employees



1 plant in China
120 employees



1 Commercial branch
Chicago, U.S.A



1 Commercial branch
near Stuttgart, Germany



What's next ?

1 Manufacturing plant in India

1 Commercial Branch in Brazil

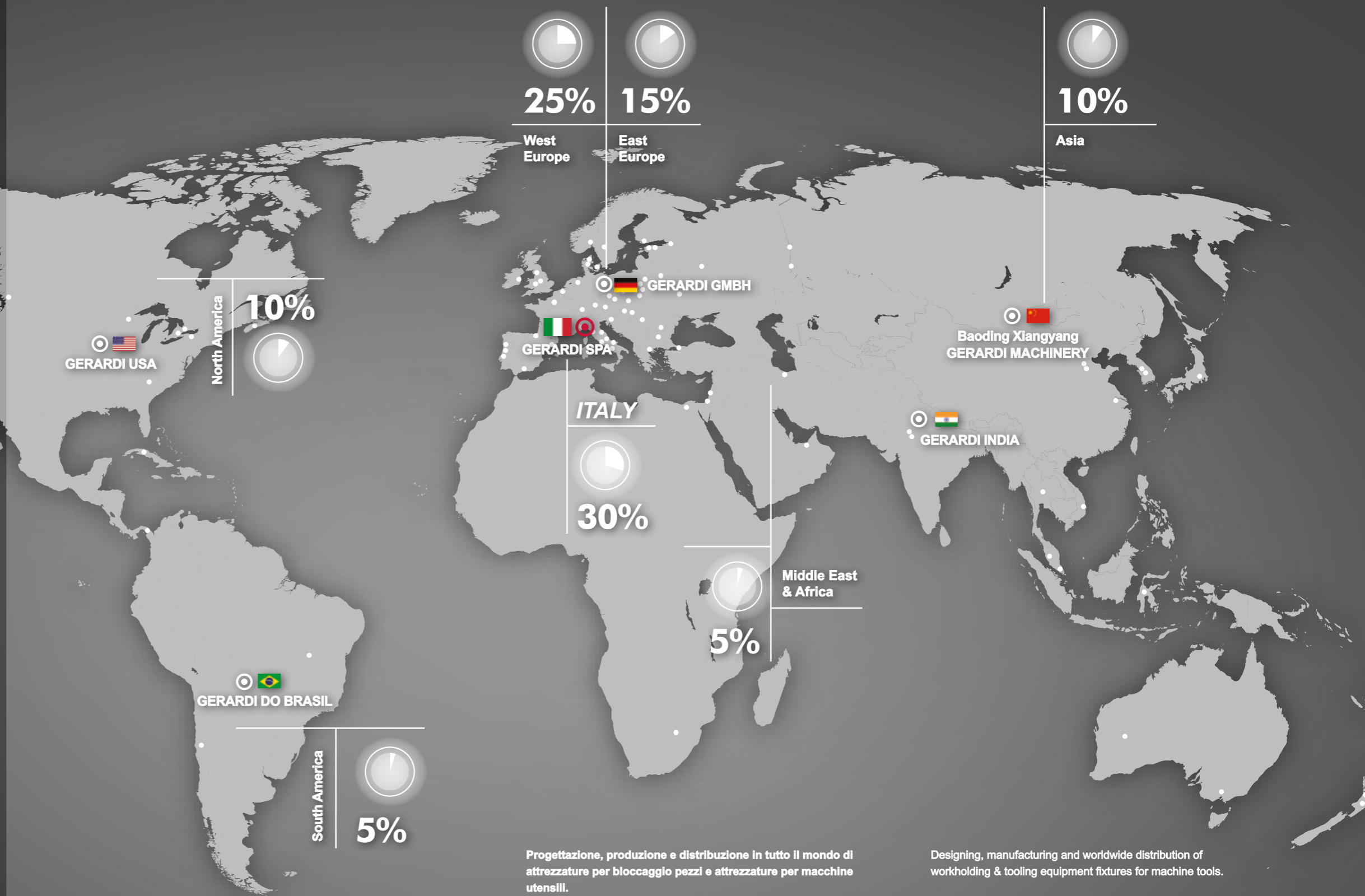

Progettazione, produzione e distribuzione in tutto il mondo di attrezzature per bloccaggio pezzi e attrezzature per macchine utensili.

Il supporto e la protezione dei nostri agenti, rappresentanti e distributori sono il nostro valore e orgoglio! Fin dall'inizio abbiamo sviluppato la distribuzione dei nostri prodotti costruendo una forte partnership con la nostra rete mondiale di distributori, che è la base per un lavoro continuo e una profonda penetrazione nel mercato.

Designing, manufacturing and worldwide distribution of workholding & tooling equipment fixtures for machine tools.



Support and protection of our agents, reps and distributors are our value & pride! Since the very beginning we've been developing our products distribution by building up a strong partnership with our worldwide distributors network, which is the base for continuous work and a deep market penetration.

01-02

XL & XL FLEX vises





Std & StandardFLEX Vises



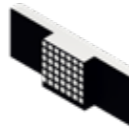

**Main
inside news**

	<p>Art.1E Art.1ZE Art.12E Art.14E Art.15E Art.1AE Art.1AZE</p> <p>Morse Standard Matic Standard Matic Vises</p> <p>Pag - Page from 1.8 to 1.23</p>
	<p>Art.62 Art.81P</p> <p>Piastre d'interfaccia per sistema Zero Point Zero Point interfaced plate</p> <p>Pag - Page 1.24</p>

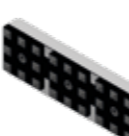
04

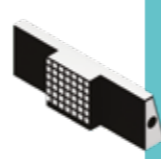
**Accessories
& Spare Parts**

	<p>Art.1E Art.1F</p> <p>Morse StandardMatic StandardMatic Vises</p> <p>Pag - Page from 4.40 to 4.43</p>
	<p>Art.242K Art.243K Art.248K Art.249K Art.246K Art.247K</p> <p>Piastre ganasce con gradino integrale e inserti grip Integral step jaw plates with grip inserts</p> <p>Pag - Page 4.16 - 4.17</p>
	<p>Art.230SLD</p> <p>Piastre ganasce a pettine quadrettate scaricate Discharged serrated comb jaw plates</p> <p>Pag - Page 4.21</p>
	<p>Art.230SLE</p> <p>Piastre ganasce a pettine con gradino scaricate Discharged step comb jaw plates</p> <p>Pag - Page 4.21</p>
	<p>Art.230K</p> <p>Piastre ganasce a pettine con inserti grip Comb jaw plates with grip inserts</p> <p>Pag - Page 4.21</p>



	<p>Art.547K</p> <p>Piastre piane con gradino integrale e inserti grip Straight integral step jaw plates with grip inserts</p> <p>Pag - Page 5.58</p>
	<p>Art.806SLD</p> <p>Piastre ganasce a pettine quadrettate scaricate Discharged serrated comb jaw plates</p> <p>Pag - Page 5.23</p>
	<p>Art.806SLE</p> <p>Piastre ganasce a pettine con gradino scaricate Discharged step comb jaw plates</p> <p>Pag - Page 5.23</p>
	<p>Art.806K</p> <p>Piastre ganasce a pettine con gradino integrale e inserti grip Integral step comb jaw plates with grip inserts</p> <p>Pag - Page 5.23</p>
	<p>Art.62 Art.81P</p> <p>Piastre d'interfaccia per sistema Zero Point Zero Point interfaced plates</p> <p>Pag - Page 5.50</p>

05

FMS Vises

06

Multiflex vises

	<p>Art.723A Art.723B Art.723C</p> <p>Ganasce per serraggio a cuneo discendente Jaws wedge clamp</p> <p>Pag - Page 6.40</p>
	<p>Art.62 Art.81P</p> <p>Piastre d'interfaccia Zero Point Zero Point interfaced plates</p> <p>Pag - Page 6.30</p>

**Devi staffare la tua morsa?
Do you need to fix your vise?**

**OGNI CAPITOLO È PROVISTO DI UNA PAGINA DEDICATA
ALLO STAFFAGGIO IN MACCHINA DELLA MORSA**

**EACH CHAPTER HAS A SPECIFIC PAGE TO SHOW THE
BEST WAY TO FIX YOUR VISE ON THE MACHINE TABLE**

07

Multitasking Vises

Devi staffare la tua morsa?
Do you need to fix your vise?

**OGNI CAPITOLO È PROVVISORIO DI UNA PAGINA DEDICATA
 ALLO STAFFAGGIO IN MACCHINA DELLA MORSA**

EACH CHAPTER HAS A SPECIFIC PAGE TO SHOW THE
 BEST WAY TO FIX YOUR VISE ON THE MACHINE TABLE

	Morse MaxiGrip Intermediated jaw
	Art.650X Ganascia intermedia Intermediated jaw
	Art.650V Art.650Y Art.650U - G01 - G02 - G11 Inserti per ganascia intermedia Intermediated jaw inserts
	Art.690DTF Utensile fresa per inserti Coda di Rondine Milling tool for Dove Tail inserts
	Art.297X Tassello a gioco Zero Zero plug play
	Art.643H Supporti piramidali Pyramidal supports
	Art.670CP Art.670AP Piastre d'interfaccia per GripMatic Interface plates for GripMatic vises

Pag - Page 7.21 - 7.27

Pag - Page 7.27

Pag - Page 7.29 - 7.51 - 7.53

Pag - Page 7.29

Pag - Page 7.17 - 7.31

Pag - Page 7.37

Pag - Page 7.48



Art.85
Pallet Kiwa
Kiwa pallet

Pag - Page 8.41



Art.62K
Kit Piastre d'interfaccia tonde per tavole rotanti
Round Interfaced plates kit for rotary table

Pag - Page 8.27 - 8.31 - 8.33



Art.53A1
Art.53B1
Art.53C1
Art.55A1
Art.53B1
Art.53C1
Cubi e spalle leggeri
Light cubes & two sides tombstones

Pag - Page 8.10 - 8.11

08

Tombstones & Pallets

09

Zero Point System



Art.665T
Zero Point Doppio
Double Zero Point

Pag - Page 9.36



Art.63
Art.64
Type 3
Rialzi per Zero Point
Zero Point Risers

Pag - Page 9.11 - 9.21



Art.297X
Tassello a gioco Zero per Zero Point
Zero play nut for Zero Point

Pag - Page 9.45



Art.ESTR01
Estrattore per spina di riferimento Zero Point
Dowel extractor for Zero Point reference pin

Pag - Page 9.45

INDICE - INDEX

Art.	Page
1	1.8
1A	1.20
1AE	1.20
1AZ	1.22
1AZE	1.22
1E	1.8 - 4.40
1F	4.42
1Z	1.10
1ZE	1.10
8	9.45
9	9.45
10A	9.40 - 9.41 - 9.42
10B	9.40 - 9.41 - 9.42
10S	9.41
11A	9.40 - 9.41 - 9.42
11B	9.40 - 9.41 - 9.42
11S	9.41
12	1.12
12E	1.12
14	1.14
14E	1.14
15	1.16
15E	1.16
20	2.8
20A	2.28
20E	2.8
20AE	2.28
21	2.10
21E	2.10
22	2.12
22E	2.12
24	2.14
24E	2.14
25	2.16
25E	2.16
30	2.18
30A	2.30
30AE	2.30
30E	2.18
32	2.20
32E	2.20
34	2.22
34E	2.22
35	2.24
35E	2.24
40	1.24

Art.	Page
40A	1.24
40Z	1.24
42	2.32
42Z	2.32
44	3.12
44A	3.12
51	3.12
51A	3.12
53A	8.8
53A1	8.10
53B	8.8
53B1	8.10
53C	8.8
53C1	8.10
53E	8.9
53F	8.9
53P	9.38
54A	8.12
54B	8.12
54C	8.12
54E	8.13
54F	8.13
54P	9.38
55A	8.14
55A1	8.11
55B	8.14
55B1	8.11
55C	8.14
55C1	8.11
55E	8.15
55F	8.15
56P	9.39
56A	8.16
56B	8.16
56C	8.16
56E	8.17
56F	8.17
56P	9.39
57A	8.18
57B	8.18
57C	8.18
57E	8.19
57F	6.42 - 8.19
57G	6.42
60C	8.25
60E	8.25
60F	8.25
60G	8.25
60H	8.25
60IC	9.30
60IE	9.32

Art.	Page
61C	8.26
61E	8.26
61F	8.26
61G	8.26
61H	8.26
61IC	9.30
61IE	9.32
62	1.24 - 5.50 - 6.30
62C	8.27
62E	8.27
62F	8.27
62G	6.27
62H	8.27
62iC	7.46 - 9.28
62IE	7.46 - 9.28
62K	DIVIGER - DPG
62L	8.31 - 8.33
62M	7.17 - 7.31
63	7.24
63 T.1	9.13
63 T.2	9.17
63 T.3	9.21
64	7.24
64 T.1	9.11
64 T.2	9.15
64 T.3	9.19
66	8.29
68	8.29
69	8.29
69A	8.29
70CP	9.24
70P	9.22
71CP	9.24
71P	9.22
72CP	7.47 - 9.24 - 9.29
72P	7.46
79	7.11 - 7.15 - 7.29
79R	6.39 - 6.42
80P	9.26
81	6.38
81P	7.24
81P	1.24 - 5.50 - 6.30 - 9.26 - 9.27
82P	7.46 - 9.28
83	7.60 - 11.17
83B	11.17

Art.	Page
83C	11.18
83D	11.18
83E	11.18
84	11.18
84U	5.31
85	8.36 / 41
85E	8.36 / 41
85F	8.36 - 8.37 - 8.38 - 8.39 - 8.41
85H	8.37
86	8.36 / 39
86G	8.28
88 T.1	10.14
88 T.2	10.15
88 T.3	10.16
88 T.4	10.17
88A T.1	10.12
88A T.2	10.13
88A T.3	10.13
88B T.1	10.12
88B T.2	10.13
88B T.3	10.13
88C T.1	10.12
88C T.2	10.13
88C T.3	10.13
88D T.1	10.12
88D T.2	10.13
88D T.3	10.13
89A	10.12
89B	10.12
89C	10.12
89D	10.10
89E	10.10
89F	10.11
89J	10.11
89P	10.9
89U	10.11
90	5.35
94	8.28
96	6.38
99A	DPG/ DIVIGER
99B	DPG/ DIVIGER
99C	8.31 - 8.33
99D	8.31 - 8.33
99E	8.31 - 8.33
99F	8.31 - 8.33
99G	8.31 - 8.33
99H	DPG/ DIVIGER

Art.	Page
99P	8.31- 8.33
99Q	9.47 - 9.49
99R	9.47 - 9.49
99S	DPG/ DIVIGER
99T	DPG/ DIVIGER
100	11.19
101	11.19
102	3.8
102A	3.9
102Ai	3.11
102i	3.10
103	3.8
103A	3.9
103Ai	3.11
103i	3.10
104	3.8
104A	3.9
104Ai	3.11
104i	3.10
105	4.31
120	4.8
120A	4.20
121	4.8
123	4.8
123A	4.20
124	4.8
126	4.8
126A	4.20
127	4.8
127A	4.20
128	4.8
129	4.8
130	1.34
130S	1.34
131	1.34
131A	1.34
131S	1.34
132	4.28
133	4.28
134	4.28
135	4.28
136	1.34
136S	1.34
137	1.34
137S	1.34
138	1.34
138D	1.34
138DS	1.34

INDICE - INDEX

Art.	Page
138S	1.34
139	1.34
139D	1.34
139DS	1.34
139S	1.34
140	4.10
140G	4.13
140T	4.12
141	4.10
141G	4.13
141T	4.12
143	4.10
143G	4.13
143T	4.12
144	4.10
144G	4.13
144T	4.12
146	4.10
146G	4.13
146T	4.12
147	4.10
147G	4.13
147T	4.12
148	4.10
148G	4.13
149	4.10
149G	4.13
150	1.34
150A	1.34
150AS	1.34
150S	1.34
152	4.24
160	4.18
161	4.18
163	4.18
164	4.18
166	4.18
167	4.18
168	4.18
169	4.18
190	4.29
191	4.29
192	4.25
192S	4.25
200	4.19
201	4.19
203	4.19
204	4.19
206	4.19
207	4.19
208	4.19

Art.	Page
209	4.19
210	4.24
211	4.24
212	1.8 - 1.10 - 1.14 - 1.20 - 1.22 - 2.8 - 2.10 - 2.14 - 2.18 - 2.22 - 2.28 - 2.30 - 4.23
213	1.12 - 2.12 - 2.20 - 4.23
214	4.23
215	4.23
217	1.8 - 1.10 - 2.8 - 2.10 - 2.18 - 4.24
218	1.12 - 1.16 - 2.12 - 2.16 - 2.20 - 2.24 - 4.24
220	7.50
220F	4.15 - 4.17
220 G01	4.15 - 4.17 - 5.58
220 G02	4.15 - 4.17 - 5.58
220 G11	4.15 - 4.17 - 5.58
224	4.23
225	4.23
230	1.20 - 1.22 - 4.9
230B	2.28 - 2.30 - 4.21
230C	4.21
230D	4.21
230E	1.20 - 1.22 - 2.28 - 2.30 - 4.22
230F	1.20 - 1.22 - 2.28 - 2.30 - 4.21
230G	4.21
230H	4.21
230K	4.21
230L	4.21
230M	4.21
230S	4.9
230SLD	4.21
230SLE	4.21
231	4.9
231S	4.9
232	4.9

Art.	Page
233	4.9
234	4.9
235	4.9
242	4.11
242G	1.8 - 1.10 - 2.8 - 2.10 - 2.18 - 4.14
242K	4.16
242S	4.11
243	2.12 - 2.20 - 4.11 - 7.56 - 7.60
243G	4.14
243K	4.16
243S	4.11
244	4.11
245	4.11 - 7.56 - 7.60
246	1.14 - 2.14 - 2.22 - 4.11
246G	1.14 - 2.14 - 2.22 - 4.14
246K	4.16
246T	4.11 - 4.12
247	1.16 - 2.16 - 2.24 - 4.11
247G	1.16 - 2.16 - 2.24 - 4.14 - 7.60
247K	4.16
247T	4.11 - 4.12 - 5.35
248	4.9
248G	4.14
248K	4.16
248S	4.9
249	4.9
249G	4.14
249K	4.16
249S	4.9
250	4.9
251	4.9
252	4.9
253	4.9
257	4.37
258	4.36
260	4.28
270A	4.53
270B	4.53
271	4.54
271D	4.54
272	4.53

Art.	Page
272A	4.53
282A	4.36
283	4.54
283A	4.54
284A	4.36
285	4.54
286	4.37
287	4.34 - 11.14
291	4.35
292	4.37
293	4.37
294A	4.37
295	4.37
296	1.6 - 2.6 - 3.6 - 4.33 - 5.6 - 6.6 - 7.6
297	4.34 - 7.11 - 7.15 - 7.29
297R	6.39 - 6.42
297X	7.29 - 9.16 - 9.45
298	4.33
298/CGR	7.29
299	4.37
300	4.29
300A	4.30
301	4.29
302	4.29
303	4.29
303A	4.30
304	4.29
305	4.29
306	4.29
306A	4.30
306B	4.30
306C	4.30
307	4.29
308	4.29
309	4.29
310	4.27
311	4.27
312	4.27
313	1.8 - 1.10 - 1.14 - 2.8 - 2.10 - 2.14 - 2.18 - 2.22 - 4.27
313A	4.26
313R	1.12 - 1.16 - 2.12 - 2.16 - 2.20 - 2.24 - 4.27

Art.	Page
313S	4.14
314	4.27
315	4.30
	

INDICE - INDEX

Art.	Page	Art.	Page
391	4.45		
391/2	4.45		
391/3	4.45		
391/4	4.45		
391A/2	4.45		
391A/3	4.45		
391A/4	4.45		
391B	4.49		
391B/2	4.49		
391B/3	4.49		
391B/4	4.49		
391C/2	4.49		
391C/3	4.49		
391C/4	4.49		
392	4.46		
392/2	4.46		
392/3	4.46		
392/4	4.46		
392A/2	4.46		
392A/3	4.46		
392A/4	4.46		
392B	4.50		
392B/2	4.50		
392B/3	4.50		
392B/4	4.50		
392C/2	4.50		
392C/3	4.50		
392C/4	4.50		
393	4.40 - 4.47		
393D	4.42 - 4.51		
394	4.40 - 4.47		
394D	4.42 - 4.51		
394GM	7.59		
395	4.40 - 4.47		
395D	4.42 - 4.51		
395GM	7.59		
396	4.47		
396GM	7.59		
396B	4.47		
396C	4.51		
396D	4.51		
397	4.47		
397B	4.47		
397C	4.51		
397D	4.51		
398	4.47		
398GM	7.59		
398B	4.47		
398C	4.51		
398D	4.51		
399	4.52 - 9.45		

Art.	Page	Art.	Page
400	4.52 - 7.59 - 9.45		
401	4.52		
402	4.52 - 7.59 - 9.45		
402/90	4.52 - 9.45		
403	4.52 - 7.59		
404	4.52		
405H	4.52		
407	4.40 - 4.44		
407A	4.40 - 4.45		
407B	4.40 - 4.46		
407C	4.42 - 4.48		
407D	4.42 - 4.49		
407E	4.42 - 4.50		
408	9.8 - 9.45		
410	4.36		
414	4.27		
414R	4.27		
420	4.31		
430	4.31		
431	4.28		
440	4.28		
450	1.30		
505	4.53		
512	5.57		
547G	5.58		
547K	5.58		
566	5.62		
569	4.54		
570	4.28		
570S	4.28		
571	5.62		
600	6.8 - 6.14		
600S	6.8 - 6.14		
600W	6.8 - 6.14		
601	6.30		
602	6.24		
602S	6.24		
602W	6.24		
603	6.31		
604	6.14 - 6.24 - 6.32 - 6.35		
604A	6.35		
604B	6.35 - 6.38		
604C	6.35		
604G	6.18 - 6.28 - 6.32		
604PC	6.39		
604R	6.39		

Art.	Page	Art.	Page
604T	6.32		
605	6.14 - 6.24 - 6.25 - 6.33		
605A	6.35		
605AS	6.35		
605B	6.35 - 6.36		
605BT	6.36		
605BS	6.35		
605C	6.35 - 6.38		
605D	6.35 - 6.38		
605E	6.35		
605F	6.35		
605G1	4.22 - 6.35		
605G2	4.22 - 6.35		
605G3	4.22 - 6.35		
605H	6.35		
605I	6.35		
605L	6.14 - 6.24 - 6.35		
605M	6.35		
605S	6.14 - 6.24 - 6.25 - 6.33		
605W	6.25 - 6.33		
606	6.8 - 6.16		
606T	6.8 - 6.16		
607	6.26		
607T	6.26		
608	6.32		
608A	6.37		
608R	6.39		
609	6.16 - 6.26 - 6.33 - 6.36		
609A	6.36		
609AT	6.36		
609B	6.36		
609BT	6.36		
609T	6.16 - 6.26 - 6.33 - 6.36		
610B	6.16 - 6.18 - 6.26 - 6.28 - 6.36		
610C	6.16 - 6.18 - 6.26 - 6.28 - 6.36		
610D	6.16 - 6.18 - 6.26 - 6.28 - 6.36		
610E	6.16 - 6.18 - 6.26 - 6.28 - 6.36		

Art.	Page	Art.	Page
610F	6.16 - 6.18 - 6.26 - 6.28 - 6.36		
610T	6.36		
610Z	6.36		
611	6.8 - 6.18		
612	6.28		
613	6.18 - 6.28 - 6.34 - 6.37		
613A	6.37		
613B	6.37		
613C	6.37		
613D	6.37		
613E	6.37		
613F	6.37		
614T	6.32		
615	6.14 - 6.24 - 6.34 - 6.37		
615A	6.37		
615AS	6.37		
615C	6.37		
615E	6.37		
615I	6.37		
615L	6.37		
615W	6.34		
616	6.39		
617	6.39		
618	6.39		
632	6.10 - 6.20		
632S	6.10 - 6.20		
632W	6.10 - 6.20		
633	6.12 - 6.22		
633S	6.12 - 6.22		
633W	6.12 - 6.22		
640	7.8 - 7.9		
640A	7.10 - 7.14		
640B	7.10		
640C	7.10		
640D	7.10 - 7.14		
640E	7.10 - 7.14		
640J	7.12 - 7.13		
640T	7.8 - 7.9		
640P	7.11 - 7.15 - 7.29		
641	7.10 - 7.14		
641H	7.8 - 7.12 - 7.16		
642	7.10		
643	7.10		
643H	7.45		
644	7.10 - 7.14		

Art.	Page	Art.	Page
645B	7.8 - 7.11		
645C	7.8 - 7.11		
645D	7.8 - 7.11		
645E	7.8 - 7.10 - 7.11		
645F	7.8 - 7.11		
645JD	7.14		
645JS	7.14		
645T	7.8 - 7.11		
646	7.10 - 7.14		
647	7.10		
650	7.20 - 7.24		
650A	7.24		
650B	7.24		
650BM	7.28		
650C	7.24		
650CM	7.28		
650D	7.24		
650D TICN	7.24		
650E	7.24		
650F	7.26		
650G	7.29		
650R	7.26		
650S	7.26		
650T G01	7.20 - 7.26		
650T G02	7.20 - 7.26		
650T G11	7.20 - 7.26		
650X	7.20 - 7.27		
650Y	7.26		
650V	7.26		
650U G01	7.26		
650U G02	7.26		
650U G11	7.26		
651H	7.20 - 7.22 - 7.30		
652	6.10 - 6.20		
652T	6.10 - 6.20		
653	6.12 - 6.22		
653T	6.12 - 6.22		
655B	7.12 - 7.15		
655C	7.12 - 7.15		
655D	7.12 - 7.15		
655F	7.12 - 7.15		
655J	7.12 - 7.15		

INDICE - INDEX

Art.	Page	Art.	Page
655L	7.27		
655M	7.27		
655N	7.27		
655P	7.27		
660	7.20 - 7.22 - 7.34 - 7.50		
660B	7.35 - 7.37 - 7.39 - 7.41 - 7.43 - 7.44		
660R	7.34		
660S	7.34		
661	7.40		
661D	7.36		
661H	7.44		
661HQ	7.44		
661R	7.40		
661S	7.40		
661SPB	7.36		
662D	7.36		
662S	7.38		
664 T.1	9.11		
664 T.2	9.15		
664 T.3	9.19		
664S T.1	9.13		
664S T.2	9.17		
664S T.3	9.21		
665 T.1	9.10 - 9.37		
665 T.2	9.14 - 9.37		
665 T.3	9.18 - 9.37		
665F	9.37		
665S T.1	9.12		
665S T.2	9.16		
665S T.3	9.20		
665SK T.1	9.12		
665SK T.2	9.16		
665SK T.3	9.20		
665T T.1	9.36		
665T T.2	9.36		
665T T.3	9.36		
665X T.1	9.11 - 9.37		
665X T.2	9.15 - 9.37		
665X T.3	9.19 - 9.37		
665SX T.1	9.13		
665SX T.2	9.17		
665SX T.3	9.21		
665K T.1	9.10		

Art.	Page	Art.	Page
665K T.2	9.14		
665K T.3	9.18		
665Z	9.45		
666	1.46		
666A	1.47		
666AS	1.47		
666B	1.47		
666BS	1.47		
666C	1.47		
666CS	1.47		
666D	1.47		
666DS	1.47		
666E	1.47		
666ES	1.47		
666F	1.47		
666FS	1.47		
666G	1.47		
666GS	1.47		
666H	1.47		
666HS	1.47		
666I	1.47 - 4.35		
666IS	1.47		
666L	1.47		
666LS	1.47		
666M	1.47		
666MS	1.47		
666N	1.47		
666NS	1.47		
666O	1.45		
666OS	1.47		
666S	1.46		
667	1.49		
668	1.48		
670AP	7.58		
670CP	7.58		
670G	7.56		
670ID	7.57		
670IDL	7.60		
670K	7.60		
670P	7.60		
670PN	7.56		
671A	7.56 - 7.60		
671B	7.56 - 7.60		
671C	7.56 - 7.60		
672	1.48		
672A	1.48		
672B	1.48		
672C	1.48		
672D	1.48		
672E	1.48		
672F	1.48		

Art.	Page	Art.	Page
672G	1.48		
672H	1.48		
672I	1.48		
672J	1.48		
680H	7.52 - 7.53		
680U	7.50		
682K	7.50		
683K	7.50		
684	7.51		
685	7.50		
690	7.63		
690G	7.63		
690DTF	7.29 - 7.63		
692	6.10 - 6.20		
693	6.12 - 6.22		
700	1.28		
701	1.30		
723A	6.40		
723B	6.40		
723C	6.40		
740PB	7.42		
740QC	7.42		
740ZPS	7.42		
750	1.28		
800	5.38		
800A	5.38		
800B	5.38		
800C	5.42		
800D	5.38		
800E	5.61		

VALIGETTE DI CAMPIONATURA - SAMPLE KIT CASE STANDARD



Art. 981

Valigetta di campionatura morsa Art. 1 T.1
Sample kit case Art. 1 T.1 vise

Cod. 0.98.10000



All'Interno - Inside:

Art.132	Art.313	Art.298
Art.133	Art.314	Art.370
Art.138	Art.271	Art.375
Art.147	Art.283	Art.376
Art.212	Art.285	-
Art.217	Art.297	-

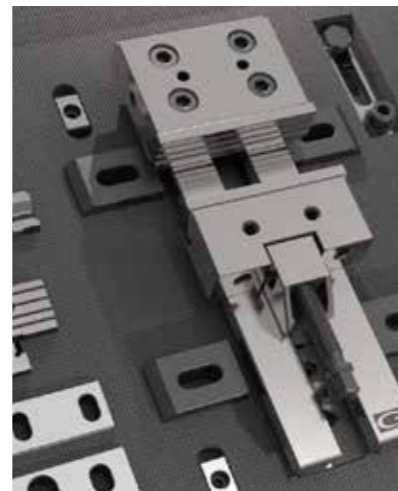

VALIGETTE DI CAMPIONATURA - SAMPLE KIT CASE MULTIFLEX



Art. 984

Valigetta di campionatura morsa Art.600 T.1x400
Sample kit case Art.600 T.1x400 vise

Cod. 0.98.40000



All'Interno - Inside:

Art.604	Art.610B	Art.297
Art.605	Art.610C	Art.298
Art.609	Art.610D	Art.370
Art.613	Art.610E	Art.375
Art.615	Art.610F	Art.376
Art.605L	Art.610T	-

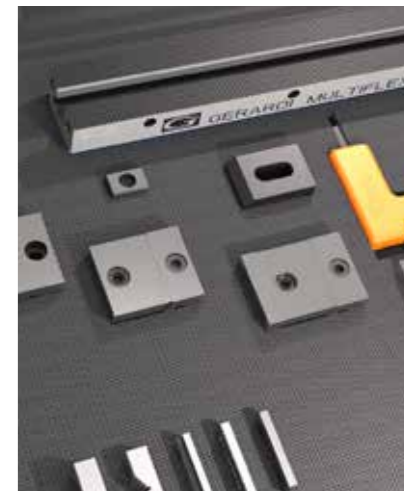

STANDARDFLEX



Art. 985

Valigetta di campionatura morsa Art. 1A T.1
Sample kit case Art. 1A T.1 vise

Cod. 0.98.5000



All'Interno - Inside:

Art.138	Art.230F	Art.271
Art.212	Art.230G	Art.297
Art.230B	Art.230H	Art.298
Art.230C	Art.230M	Art.370
Art.230D	Art.313	Art.375
Art.230E	Art.314	Art.376

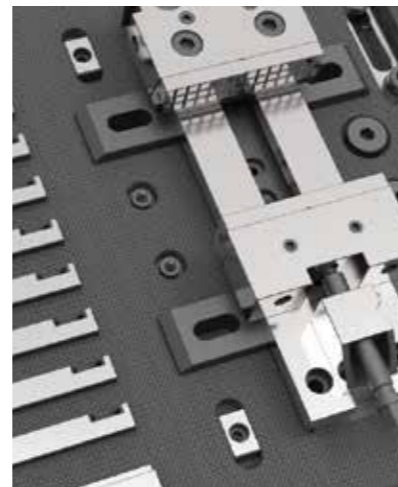

COMPACT GRIP

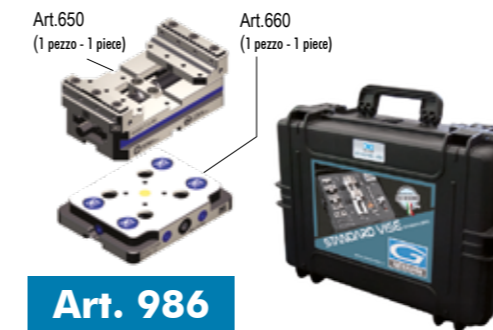

Art. 986

Valigetta di campionatura morsa Art.650 - Art.660 T.2x160
Sample kit case Art.650 - Art.660 T.2x160 vise

Cod. 0.98.60000



All'Interno - Inside:

Art.11A	Art.650G G11	Art.297
Art.650X	Art.650G G02	Art.370/EM
Art.950D	Art.650G G01	Art.375
Art.950B	Art.650R	Art.376 CH3/CH6
Art.660B	Art.650S	Art.650G
Art.79	Art.298/CGR	Art.650GZ



FMS



Art. 983

Valigetta di campionatura morsa Art.860 T.1x300
Sample kit case Art.860 T.1x300 vise

Cod. 0.98.30000



All'Interno - Inside:

Art.810L	Art.806B	Art.297 16/18
Art.807	Art.806C	Art.850H
Art.810X	Art.806D	Art.370 T1 Std
Art.814	Art.806E	Art.375 CH12
Art.810J	Art.806F	-
Art.814	Art.298	-



ZERO POINT & MULTITASKING

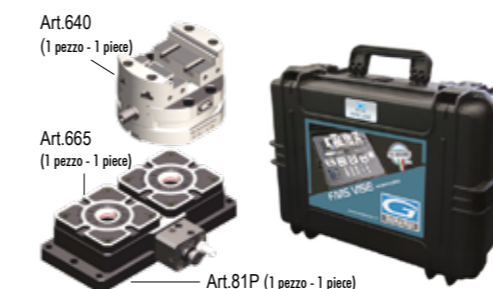

Art. 982

Valigetta di campionatura morsa Art.640 - Art.665 - Art.81P
Sample kit case Art.640- Art.665 - Art.81P

Cod. 0.98.20000

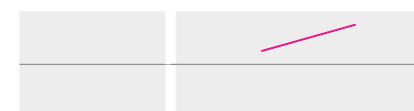

All'Interno - Inside:

Art.10A Art.11A	Art.645T	Art.655J
Art.645B	Art.640P	Art.370
Art.645C	Art.655B	Art.375
Art.645D	Art.655C	Art.376
Art.645E	Art.655D	Art.377
Art.645F	Art.655F	Art.297 Art.298

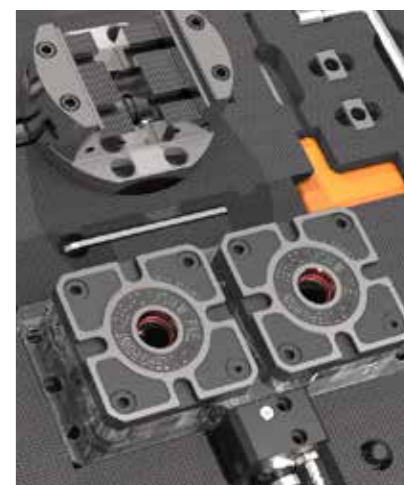

GERARDI DISPLAYS

SCEGLI E CONFIGURA IL TUO DISPLAY GERARDI
CHOOSE AND SET YOUR GERARDI DISPLAY

METALEX DISPLAY

Art. 75M Espositore in metallo
Metal made display

Cod. 0.ESP.75M0

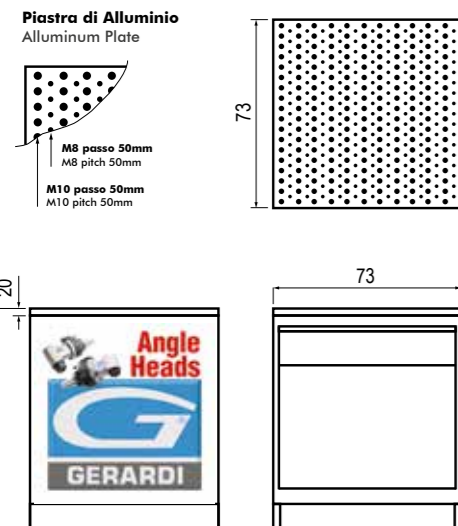

IDEALE PER PER FIERE
IDEAL FOR EXHIBITIONS

- Piastra a reticolo in alluminio
- 3/4 cassetti su richiesta
- Adesivi personalizzabili su richiesta

- Grid aluminum plate
- 3/4 drawers on request
- Customizable stickers on request

Cyano
Cyan



CONFIGURAZIONI DISPONIBILI - AVAILABLE SETTINGS

Configurazioni variabili - Changeable settings

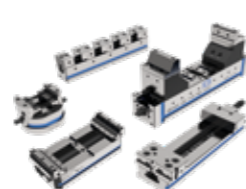

- 1 Std/flex
- 1 Fms
- 1 Multiflex
- 1 Compact
- 1 Multitasking



- 1 Std
- 1 Fms
- 1 Multiflex
- 1 CompactGrip
- 1 Zero Point



- 1 Std / StandardFLEX
- 1 CompactGrip
- 2 Angle Heads
- 2 Driven tools

GERARDI DISPLAYS

SCEGLI E CONFIGURA IL TUO DISPLAY GERARDI
CHOOSE AND SET YOUR GERARDI DISPLAY

WOODEN PLUS DISPLAY

Art. 90W Espositore in melaminico 90x90
Melaminic display 90x90

Cod. 0.ESP.90W0

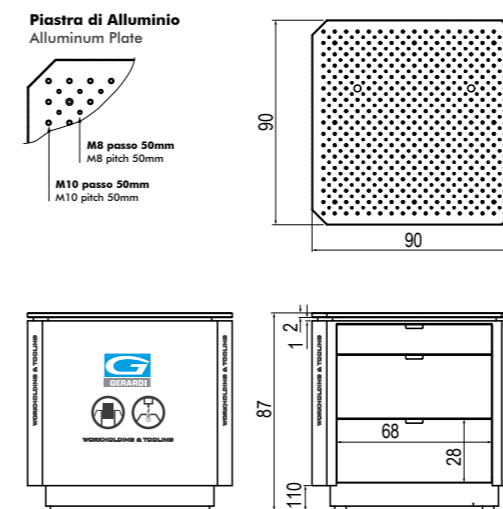

IDEALE PER GRANDI SHOWROOM
IDEAL FOR BIG SHOWROOM

- Piastra a reticolo in alluminio
- 3/4 cassetti su richiesta
- Adesivi personalizzabili su richiesta
- Luce LED personalizzabile

- Grid aluminum plate
- 3/4 drawers
- Customizable stickers on request
- Customizable LED light

Grigio Chiaro
Light Grey



CONFIGURAZIONI DISPONIBILI - AVAILABLE SETTINGS

Configurazioni variabili - Changeable settings

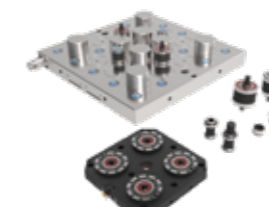

- 1 Std/flex
- 1 Fms
- 1 Multiflex
- 1 Compact
- 1 Multitasking



- 1 Std
- 1 Fms
- 1 Multiflex
- 1 CompactGrip
- 1 Zero Point



- 1 Std / StandardFLEX
- 1 CompactGrip
- 2 Angle Heads
- 2 Driven tools

WOODEN STD DISPLAY

Art. 75W Espositore in melaminico 73x73
Melaminic display 73x73

Cod. 0.ESP.75W0

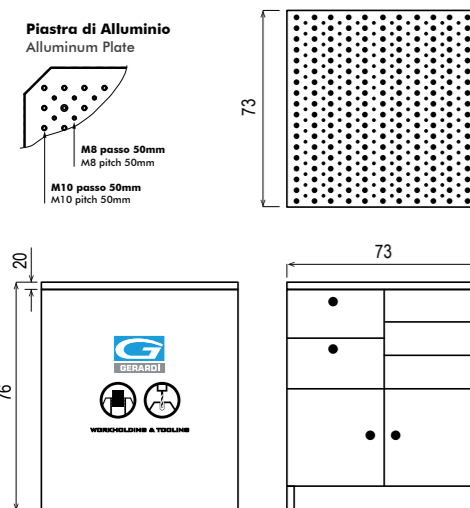

IDEALE PER SHOWROOM
IDEAL FOR SHOWROOM

- Piastra a reticolo in alluminio
- 2 cassetti + 2 vani + 3 ripiani
- Adesivi personalizzabili su richiesta
- Luce LED personalizzabile

- Grid aluminum plate
- 2 drawers + 2 compartments + 3 shelves
- Customizable stickers on request
- Customizable LED light

Grigio Chiaro
Light Grey



CONFIGURAZIONI DISPONIBILI - AVAILABLE SETTINGS

Configurazioni variabili - Changeable settings

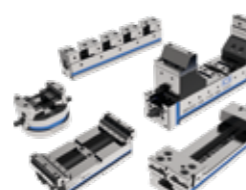

- 1 Std/flex
- 1 Fms
- 1 Multiflex
- 1 CompactGrip
- 1 Multitasking



- 1 Std
- 1 Fms
- 1 Multiflex
- 1 CompactGrip
- 1 Zero Point



- 1 Std / StandardFLEX
- 1 CompactGrip
- 1 Angle Head
- 2 Driven tools

WOODEN STEP DISPLAY

Art. 90WT Espositore 4 livelli in melaminico 90x90
Melaminic display 90x90 with 4 steps

Cod. 0.ESP.90WT0

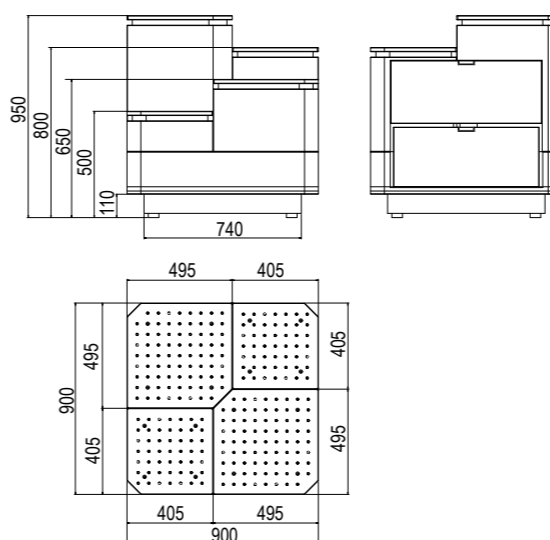

IDEALE PER GRANDI SHOWROOM
IDEAL FOR BIG SHOWROOM

- Struttura rinforzata
- Piastra a reticolo in alluminio
- 3 cassetti
- Adesivi personalizzabili su richiesta
- Luce LED personalizzabile

- Reinforced display
- Grid aluminum plates
- 3 drawers
- Customizable stickers on request
- Customizable LED light

Grigio Chiaro
Light grey



CONFIGURAZIONI DISPONIBILI - AVAILABLE SETTINGS

Configurazioni variabili - Changeable settings

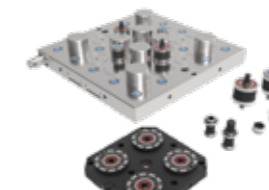

- 1 MillTecZero
- 1 Zero Point plate
- 1 CompactGrip vise



- 1 Std
- 1 Fms
- 1 Multiflex
- 1 CompactGrip
- 1 Zero Point



- 1 Grid Cube
- 2 Angle Head
- 2 Driven tools
- 4 Vises

CERTIFICATO

DI GARANZIA 



CERTIFICATO DI GARANZIA GERARDI GARANTISCE I MATERIALI DELLA MIGLIOR QUALITÀ

La **GERARDI SPA** garantisce, per un periodo di **5 ANNI**, la buona qualità dei materiali impiegati e la perfetta costruzione su tutta la gamma di morse modulari e cubi portapezzi ad azionamento manuale. Per quanto riguarda i sistemi pneumatici, idraulici e magnetici e teste angolari la garanzia si estende per **12 MESI** mentre per portautensili motorizzati a rotazione meccanica la garanzia si estende per **24 MESI**. Per effetto di questa garanzia, la **GERARDI SPA** si impegna a provvedere alla riparazione o sostituzione di quelle parti che risultassero difettose per impiego di cattivo materiale o per vizio di costruzione, purché dette parti vengano consegnate in ogni caso in porto franco al suo stabilimento. La garanzia non si estende a guasti o rotture derivati da imperizia, trascuratezza o cattivo uso del prodotto da parte dell'acquirente e cessa qualora i pagamenti non vengano effettuati dal compratore alle scadenze convenute o quando il prodotto venga modificato o riparato dall'utilizzatore. Tutti i prodotti Gerardi sono marchiati e riconoscibili a vista. Su prodotti di dubbia provenienza e non marchiati non sarà riconosciuta nessuna garanzia.





FIRMA





FIRMA

CERTIFICATE

OF GUARANTEE 



GERARDI GUARANTEE CERTIFICATE OF THE BEST QUALITY OF MATERIAL EMPLOYED

GERARDI SPA guarantees for a period of **5 YEARS** the good quality of materials employed and the perfect construction of the complete range of modular vises and tombstones with manual control. As far as pneumatic, hydraulic and magnetic items and angular heads the warranty extends for **12 MONTHS** while for driven tools with mechanical running the warranty extends for **24 MONTHS**. For this warranty **GERARDI SPA** commits herself to repair or substitute any part which shall result defected by workmanship or for the use of bad quality material only on condition that such parts shall be delivered free port to our factory. This warranty does not extend to breakages arising from unskilfulness or carelessness and negligent use of the items from the buyer side and terminate in case the payments are not made as agreed and when the item shall be modified or repaired by the user. Each Gerardi item has been branded and it is easy recognizable at first sight. On items of uncertain origin and not marked no warranty will be allowed.





SIGNATURE





SIGNATURE

ATTENZIONE - ATTENTION

Le caratteristiche tecniche indicate in questo catalogo non sono impegnative e possono essere modificate senza preavviso

The technical data contained herein are given for information only and are subject to change without notice

CONDIZIONI GENERALI DI VENDITA

1- ORDINAZIONI:

L'importo minimo delle ordinazioni è fissato in Euro 150,00 netto (IVA esclusa). Solo su specifica richiesta del cliente importi inferiori saranno evasi con un addebito fisso di 10,00 euro per spese di gestione.

2- PREZZI:

I prezzi indicati nel seguente listino sono espressi in Euro (IVA esclusa) e sono suscettibili di modifiche senza preavviso. Consigliamo pertanto di indicare sempre nei Vostri ordini il riferimento del listino in Vostre mani (N° / Anno). I listini aggiornati in tempo reale sono disponibili on line www.gerardi.it come anche eventuali Errata Corrige.

Il Costruttore declina inoltre ogni responsabilità per eventuali errori di stampa contenuti in questa pubblicazione

3- PAGAMENTO:

I pagamenti devono essere effettuati nei termini e alle condizioni concordate. In caso di ritardato pagamento, verranno addebitate le spese e gli interessi di mora al tasso bancario corrente maggiorato di due punti.

4- MODIFICHE:

Modifiche di ogni tipo o errori di stampa dei nostri cataloghi o listini non danno diritto a reclami. Le rappresentazioni grafiche non sono impegnative.

5- RESA:

I prezzi si intendono per merce resa franco ns. magazzino in Lonate Pozzolo (VA).

6- IMBALLO:

L'imballo verrà addebitato al costo in caso fosse necessario.

7- TRASPORTO:

La merce viaggia sempre a rischio e pericolo del committente.

8- TERMINI DI CONSEGNA:

La maggior parte degli ordini viene evaso entro le 48 ore successive al ricevimento degli stessi (Il nostro personale addetto avviserà per la conferma del ritiro). I termini di consegna per gli articoli non disponibili in stock sono puramente indicativi e pertanto non vincolanti. Non assumiamo responsabilità alcuna per eventuali ritardi di consegna causati da motivi di forza maggiore.

9- VALIDITA' OFFERTE:

Le offerte sono valide trenta giorni dalla data della loro emissione.

10- RECLAMI:

Ogni particolare ed ogni spedizione è accuratamente controllata, eventuali reclami dovranno pervenire in forma scritta, entro otto giorni dal ricevimento del materiale.

11- GARANZIE:

La precisione, la qualità e le caratteristiche tecniche dei nostri prodotti sono garantite e gli articoli che saranno riconosciuti difettosi, verranno sostituiti gratuitamente, senza che ciò possa dar luogo ad alcun addebito a nostro carico per spese o danni in genere. Sono esclusi dalla nostra garanzia i pezzi manomessi, modificati, danneggiati per normale logorio, o per uso scorretto.

7- LIABILITY:

Goods supplied will be the responsibility of the buyer during transportation

8- DELIVERY:

A) Standard Products:

All incoming Purchase Orders will be acknowledged within 24 hours of receipt. Delivery dates will be confirmed and wherever possible, goods will be shipped within the following working day.

For goods not available from stock, our employees will provide delivery information based on that available from within the Gerardi system. We do not accept any responsibility for delays in delivery due to circumstances that are beyond our control. Partial shipments for Purchase Orders with multiple units can be made. Cancellation of Purchase Orders cannot be made without agreement with Gerardi Spa, requests to cancel a Purchase Order must be made in writing and agreed and approved by Gerardi Spa.

B) Non-Standard or Special Products:

All incoming Purchase Orders for Non-Standard or Special Products will be acknowledged within 48 hours of receipt and delivery dates will be confirmed as soon as practically possible.

Cancellation of Purchase Orders cannot be made without agreement with Gerardi Spa, requests to cancel a Purchase Order for Non-Standard Products must be made in writing and agreed and approved by Gerardi Spa. Any costs incurred at the time of cancellation will be to the customers account.

9- OFFER VALIDITY:

Any complaint regarding shipment of goods from Gerardi S.p.A, must be made in writing within 8 days of receipt of the said goods.

10- COMPLAINT:

Any item and component and each shipment is checked carefully and any possible complaints must be written, within 8 days from goods receiving.

11- GUARANTEES:

All Gerardi spa products carry a 1 Year guarantee. This guarantee covers the performance, accuracy, quality and technical features stated in our catalog. Non-conforming products will be exchanged without charge

12- RESI:

Al fine di regolamentare le richieste di RESO PER ERRATA ORDINAZIONE da parte della Clientela, siamo costretti a precisare alcune regole, alle quali preghiamo scrupolosamente di volerVi attenere:

A) Le richieste di reso dovranno pervenire entro 8 giorni dalla data di ricezione della merce.

B) Le richieste, necessariamente scritte, devono attendere la risposta della Gerardi S.p.A. che si riserva la facoltà di accettarle.

C) Nella bolla di reso devono essere riportati gli estremi della fattura o bolla di consegna.

D) Il materiale viaggerà a spese del cliente.

E) Le confezioni dovranno essere integre ed originali.

F) nell'eseguire la nota di accredito verranno trattenuti 15,00 Euro ogni 150,00 Euro del valore del reso stesso per spese di ricollauda e nuovo stoccaggio.

13-GIURISDIZIONE:

Il foro competente in via esclusiva per la risoluzione di qualsivoglia controversia in relazione alla interpretazione e/o esecuzione delle presenti condizioni di vendita sarà quello di Busto Arsizio (VA).

12-PENALI

In caso di recesso da parte del cliente, l'acconto versato per l'ordine o per la fornitura di merce verrà trattenuto come penale.

or expense for any failure caused by defective work or components, supplied or carried out by Gerardi Spa. Any items or components that have been modified, damaged or suffered fair wear and tear, are excluded from this guarantee.

12- RETURNS POLICY:

The following procedure must be followed when returning goods, regardless of the reason for the return.

A) gerardi spa must receive written notification regarding any goods that are being returned, this notification must be received within 8 days of receipt of the goods. this notification must be sent in writing to gerardi spa.

B) goods should not be returned until gerardi spa has authorized the return and provided a delivery address to which the goods should be sent.

C) when returning goods, details of the invoice and any other relevant information must accompany the goods.

D) goods being returned must be returned free of charge.

E) goods should be returned in the original packaging and be without damage or wear.

F) a total of 10% of the invoiced value of the goods will be deducted from any credit note which gerardi issues, this charge is to cover administration and re-stocking charges only.

13-JURISDICTION:

Purchasers agree to submit any claim or discussion related to these Standard Conditions of Sale to the relevant and competent Law Courts that will be in Busto Arsizio (VA) Italy whose decision will be final.

12-PENALTIES

In the event of customer's withdrawal, the down payment for the order or supply of goods will be held as penalty.



PIÙ SEMPLICE / PIÙ INFO / PIÙ PRODOTTI - EASIER / MORE INFO / MORE PRODUCTS

TROVA IL TUO PRODOTTO IN POCHI CLICK - FIND YOUR PRODUCT IN FEW CLICKS



by category



by code



by description



by configurator

Un nuovo modo facile e veloce per ordinare la tua attrezzatura Gerardi.

Il nuovo Gerardi estore offre la possibilità di visualizzare e ordinare qualsiasi articolo Gerardi appartenente alle categorie Workholding o Tooling presente sui nostri listini in modo semplice, veloce e completo. Da ora puoi ordinare la morsa, la testa angolare o il motorizzato che ti interessa direttamente on-line dal nostro estore senza costi aggiuntivi.

A new quick and easy way to order your equipment branded Gerardi.

The new Gerardi estore offers the ability to view and order any item available on our Workholding and Tooling catalogues with the easiest, fastest and comprehensive way. You can now order the vise, angle head or driven tool of your interest directly online from our store without any additional cost.



IMMERGITI A 360° NEL MONDO GERARDI - 360° EXPERIENCE IN THE GERARDI WORLD



virtual reality



many contents



24h accessible

Visita il nostro showroom in qualunque momento!

Immergiti completamente nel mondo Gerardi e scopri tutti i prodotti Workholding e Tooling presenti nel nostro showroom attraverso il nuovo tour virtuale 360°. Visualizza i molteplici contenuti multimediali e resta sempre aggiornato!

Visit our showroom anytime you want !

Immerse yourself in the Gerardi world and discover all the Workholding and Tooling products displayed in our showroom through our 360° virtual tour. Find out all the multimedia contents and stay up to date!



WINDOWS / IOS



ANDROID / IPHONE



WINDOWS / IOS



ANDROID / IPHONE



Your updates start now!



Scansiona il QR code ed iscriviti alla nostra newsletter per restare sempre aggiornato!

Scan the QR code and subscribe to our newsletter and stay updated!

FEW MINUTES TO DESCRIBE A LONG STORY

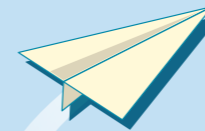

ISCRIVITI ORA

Inserisci la tua e-mail!

INVIA



Scansiona il QR CODE per guardare il video aziendale!

Scan the QR Code to watch the Gerardi corporate video!

Gerardi corporate video

La selezione delle attrezzature più particolari realizzate dal nostro ufficio tecnico raccolta e spedita con una serie di newsletter periodiche.

A selection of the best fixtures designed by our technical department and shown on a proper newsletter series titled "Fixture of the Week"



Scopri l'offerta speciale Gerardi rinnovata ogni 6 mesi e contenente molteplici promozioni su una selezione di nostri prodotti.

Find out the Gerardi Special Offers and the many great new products with an unbeatable price / quality ratio!



Una presentazione delle novità tecniche più recenti realizzate da Gerardi e moltissimi contenuti all'interno da scoprire.

An introduction to the latest technical developments of our technical department with many contents to discover



Aggiorniamo spesso i nostri principali cataloghi e listini Workholding & Tooling, iscriviti per restare sempre informato!

We constantly update our main Workholding and Tooling catalogues and price lists, subscribe to be always up-to-date!

0 1 2 3 4 5 6 7 8 9 10 11 12 13 14 15 16 17 18 19

0

1

2

3

4

5

6

7

8

9

10

11

12

13

14

15

16

17

18

19

20

21

22

23

24

25

26

27